

Third Quarter 2014 results

28 October 2014



Safe harbor

Non-GAAP measures and management estimates

This financial report contains a number of non-GAAP figures, such as EBITDA and Free Cash Flow ('FCF'). These non-GAAP figures should not be viewed as a substitute for KPN's GAAP figures.

KPN defines EBITDA as operating result before depreciation and impairments of PP&E and amortization and impairments of intangible assets. Note that KPN's definition of EBITDA deviates from the literal definition of earnings before interest, taxes, depreciation and amortization and should not be considered in isolation or as a substitute for analyses of the results as reported under IFRS as adopted by the European Union. In the Net Debt / EBITDA ratio, KPN defines Net Debt as the nominal value of interest bearing financial liabilities excluding derivatives and related collateral, representing the net repayment obligations in Euro, taking into account 50% of the nominal value of the hybrid capital instruments, less net cash and short-term investments, and defines EBITDA as a 12 month rolling total excluding restructuring costs, incidentals and major changes in the composition of the Group (acquisitions and disposals). Free Cash Flow is defined as cash flow from operating activities plus proceeds from real estate, minus capital expenditures (Capex), being expenditures on PP&E and software and excluding tax recapture regarding E-Plus. Revenues are defined as the total of revenues and other income unless indicated otherwise. Adjusted revenues and adjusted EBITDA are derived from revenues (including other income) and EBITDA, respectively, and are adjusted for the impact of restructuring costs and incidentals.

The term service revenues refers to wireless service revenues. Underlying service revenues are derived from service revenues adjusted for the impact of MTA and roaming (regulation) and incidentals.

All market share information in this financial report is based on management estimates based on externally available information, unless indicated otherwise. For a full overview on KPN's non-financial information, reference is made to KPN's quarterly factsheets available on www.kpn.com/ir

Forward-looking statements

Certain statements contained in this financial report constitute forward-looking statements. These statements may include, without limitation, statements concerning future results of operations, the impact of regulatory initiatives on KPN's operations, KPN's and its joint ventures' share of new and existing markets, general industry and macro-economic trends and KPN's performance relative thereto and statements preceded by, followed by or including the words "believes", "expects", "anticipates", "will", "may", "could", "should", "intends", "estimate", "plan", "goal", "target", "aim" or similar expressions.

These forward-looking statements rely on a number of assumptions concerning future events and are subject to uncertainties and other factors, many of which are outside KPN's control that could cause actual results to differ materially from such statements and speak only as of the date they are made. A number of these factors are described (not exhaustively) in the Integrated Annual Report 2013.

Contents

1	Chairman's review	Eelco Blok
2	Group financial review	Steven van Schilfgaarde
3	Group operating review	Eelco Blok
4	Concluding remarks	Eelco Blok

Executive summary

Good strategic progress

Good strategic progress

- Continued customer base growth 4G, IPTV and multi play in The Netherlands
- Strong growth Consumer fixed-mobile bundles (+84k) and Business multi play seats (+37k)
- Return to growth in broadband (+6k), good IPTV net adds (+49k)
- High postpaid net adds in Consumer Mobile (+84k)
- >1.7m 4G customers in The Netherlands
- Strong improvement customer satisfaction The Netherlands, NPS well above market averages
- BASE Company showed good postpaid net adds (+18k)

Simplification

- Simplification program well on track
 - YTD '14 Capex and opex savings ~€ 100m y-on-y
 - ~475 FTE reductions YTD '14

Executive summary

Financial results

- Adjusted revenues -4.9% y-on-y in Q3 '14 versus -7.0% in Q2 '14
 - Positive impact customer base growth, but still lower mobile price levels y-on-y and ongoing decline of business market size
- Adjusted EBITDA (excl. phasing out handset lease) -12% y-on-y in Q3 '14 versus -13% in Q2 '14
 - Lower revenues, partly offset by positive impact Simplification
- Capex YTD '14 23% lower y-on-y driven by lower customer driven investments, lower network investments and Simplification
- Free cash flow YTD '14 reflects phasing

Sale of E-Plus completed

- € 5bn cash and attractive 20.5% stake in Telefónica Deutschland
- DTA of € 1.2bn, limited tax cash out in The Netherlands in coming years
- Dividend payments recommenced

Use of proceeds

- Cash proceeds increasing financial flexibility, up to € 2.0bn allocated for bond tender to reduce gross debt

Sale of E-Plus successfully completed

Cash proceeds increasing financial flexibility

Use of cash proceeds

- Majority of cash proceeds to increase financial flexibility
 - Bond tender
 - Regular bond redemptions
 - Intended Reggefiber consolidation
 - Pension fund agreement
- Strengthened financial position provides solid platform to execute strategy
- Dividend payments recommenced

Bond tender

- Up to € 2.0bn allocated for bond tender
 - Tender period 28 October - 4 November 2014
- Tender EUR and GBP senior unsecured bonds with remaining maturities <10 years
- Realigning financial profile with new company profile

Shareholder remuneration

Dividend payments recommenced

- Intended DPS of € 0.07 in respect of 2014
- € 0.02 interim dividend paid in October 2014 following closing E-Plus sale
- € 0.05 final dividend expected in April 2015
- Growing DPS expected in respect of 2015



Additional excess cash

- 20.5% stake Telefónica Deutschland treated as financial investment
 - Cash upside via dividend payments
 - Exposure to >€ 5bn synergy potential
- Excess cash could be utilized for
 - Operational / financial flexibility
 - (Small) in-country M&A
 - Shareholder remuneration



Outlook (continuing operations)¹

On track to reach outlook

2014

- Financial performance stabilizing towards the end of 2014
- Capex < € 1.4bn²

2015

- Capex < € 1.5bn, including Reggefiber²
- Free cash flow (excl. TEFD dividend)³ growth expected in 2015
 - Limited tax cash out in The Netherlands in coming years due to tax loss on sale of E-Plus
 - Interest payments trending down due to reduction of gross debt in coming years
- Additional excess cash via potential dividend from 20.5% stake Telefónica Deutschland

¹ The release of the pension provision and related one-off lump-sum payment are seen as incidentals and therefore excluded from the outlook

² Assuming Reggefiber consolidation per 31 December 2014

³ Free cash flow outlook defined as cash flow from operating activities, plus proceeds from real estate, minus Capex and excluding potential Telefónica Deutschland dividend

Contents

1	Chairman's review	Eelco Blok
2	Group financial review	Steven van Schilfgaarde
3	Group operating review	Eelco Blok
4	Concluding remarks	Eelco Blok

Group financial profile

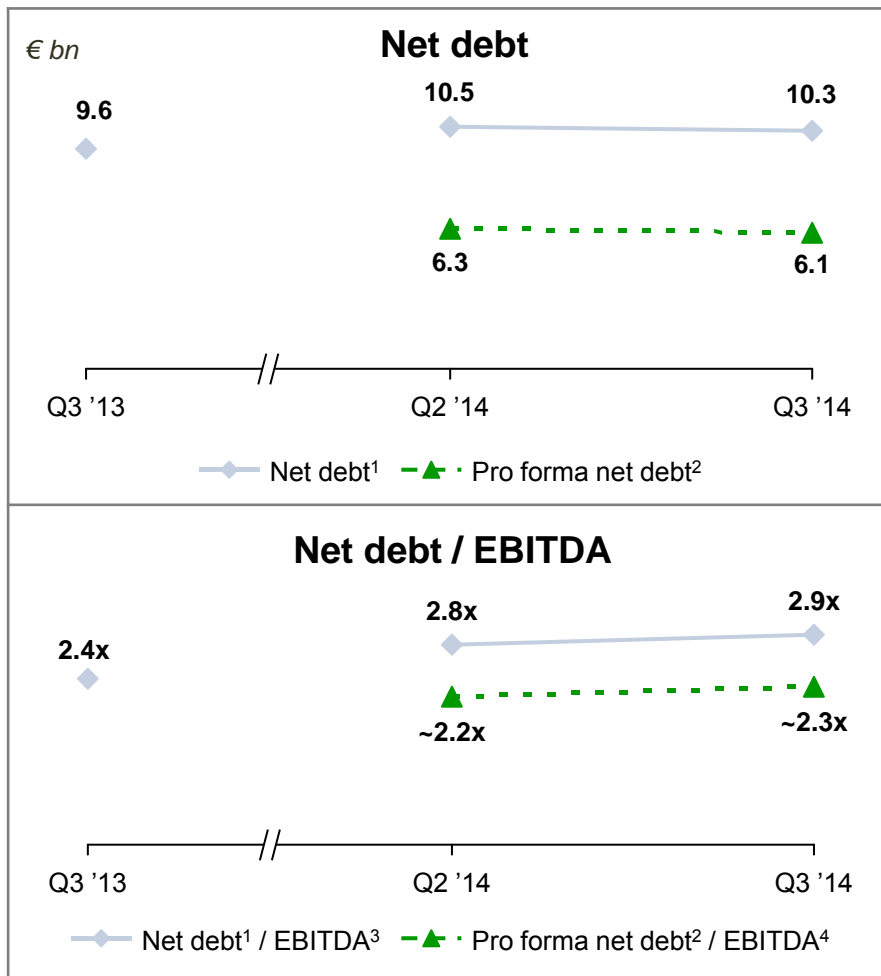

- Pro forma net debt of € 6.1bn
- Average coupon senior bonds 4.9%, average maturity senior bonds 6.8 years
- Net debt / EBITDA at ~2.3x, pro forma E-Plus sale and Reggefiber consolidation
 - Lower 12 months rolling EBITDA
 - Partly offset by lower net debt
- Pension fund agreement announced in Q2 '14 improving KPN's financial risk profile

1 Net repayment obligations in Euro, taking into account 50% of the nominal value of the hybrid capital instruments, less net cash and short-term investments
 2 Pro forma adjustment, including net cash proceeds E-Plus sale and Reggefiber consolidation impact
 3 Based on 12 months rolling total excluding restructuring costs, incidentals and major changes in the composition of the Group (acquisitions and disposals)
 4 Pro forma adjustment: i) excluding last 12 months E-Plus EBITDA; ii) including Reggefiber consolidation impact

Group results Q3 '14 (continuing operations)

€ m (continuing operations)	Q3 '14	Q2 '14	Q3 '13	y-on-y %
Revenues	1,978	2,004	2,080	-4.9%
Adjusted revenues¹	1,978	1,989	2,080	-4.9%
Opex (excl. D&A)	1,345	937	1,337	0.6%
EBITDA ²	633	1,067	743	-15%
Adjusted EBITDA³	650	633	762	-15%
– Depreciation ⁴	294	319	319	-7.8%
– Amortization ⁴	146	143	143	2.1%
Operating expenses	1,785	1,399	1,799	-0.8%
Operating profit	193	605	281	-31%
Financial income/expense	-255	-161	-176	45%
Share of profit of associates	-3	-	-3	flat
Profit before taxes	-65	444	102	n.m.
Taxes	-11	-95	-15	-27%
Profit after taxes	-76	349	87	n.m.

- Adjusted revenues down 4.9% y-on-y (Q2 '14: -7.0%)
 - Lower mobile price levels y-on-y and ongoing decline business market size
 - Partly offset by positive impact customer base growth
- Opex (excl. D&A and impact phasing out handset lease) decreased 1.2% y-on-y
- Adjusted EBITDA (excl. impact phasing out handset lease of ~€ 21m) down 12% y-on-y (Q2 '14: -13%)
 - Declining revenues partly offset by positive impact Simplification
- Net profit of € 38m excluding impact revaluation Reggefiber option (€ -114m)

1 Adjusted revenues are derived from revenues and other income and are adjusted for the impact of incidentals
 2 Defined as operating profit plus depreciation, amortization & impairments
 3 Adjusted EBITDA is derived from EBITDA and is adjusted for the impact of restructuring costs and incidentals
 4 Including impairments, if any

Group results YTD '14 (continuing operations)

€ m (continuing operations)	YTD '14	YTD '13	%
Revenues	5,978	6,411	-6.8%
Adjusted revenues¹	5,956	6,374	-6.6%
Operating expenses (excl. D&A)	3,654	4,109	-11%
EBITDA ²	2,324	2,302	1.0%
Adjusted EBITDA³	1,904	2,332	-18%
– Depreciation ⁴	919	930	-1.2%
– Amortization ⁴	428	444	-3.6%
Operating expenses	5,001	5,483	-8.8%
Operating profit	977	928	5.3%
Financial income/expense	-575	-514	12%
Share of profit of associates	-4	-7	-43%
Profit before taxes	398	407	-2.2%
Taxes	-122	-6	>100%
Profit after taxes	276	401	-31%

- Adjusted revenues down 6.6% y-on-y
- Opex (excl. D&A, pension release and impact phasing out handset lease) decreased 3.2% y-on-y
 - Lower personnel costs in The Netherlands
- Adjusted EBITDA (excl. impact phasing out handset lease of ~€ 112m) down 14% y-on-y
- Reported EBITDA supported by € 451m release of pension provision (€ 361m net of tax) in Q2 '14

1 Adjusted revenues are derived from revenues and other income and are adjusted for the impact of incidentals

2 Defined as operating profit plus depreciation, amortization & impairments

3 Adjusted EBITDA is derived from EBITDA and is adjusted for the impact of restructuring costs and incidentals

4 Including impairments, if any

Group cash flow Q3 '14 (continuing operations)

€ m (continuing operations)	Q3 '14	Q3 '13	%
EBITDA	633	743	-15%
Interest paid/received	-130	-168	-23%
Tax paid/received	-14	-82	-83%
Change in provisions ¹	-8	-55	-85%
Change in working capital ¹	48	-78	<i>n.m.</i>
Other movements	3	2	50%
Net cash flow from operating activities	532	362	47%
Capex²	283	357	-21%
Proceeds from real estate	1	-	<i>n.m.</i>
Tax recapture E-Plus	-	58	-100%
Free cash flow³	250	63	>100%
Coupon on perpetual hybrid	-67	-34	97%

- Free cash flow higher y-on-y at € 250m mainly due to

- € 126m more cash from change in working capital
- € 74m lower Capex
- € 47m more cash from change in provisions
- € 38m lower interest paid

Partly offset by

- € 110m lower EBITDA

- Capex 21% lower y-on-y

- Lower customer driven investments, incl. phasing out of handset lease
- Lower mobile network investments
- Simplification

¹ Excluding changes in deferred taxes

² Including property, plant & equipment and software

³ Defined as cash flow from operating activities, plus proceeds from real estate, minus Capex and excluding tax recapture E-Plus

Group cash flow YTD '14 (continuing operations)

€ m (continuing operations)	YTD '14	YTD '13	%
EBITDA	2,324	2,302	1.0%
Interest paid/received	-585	-584	0.2%
Tax paid/received	-27	-218	-88%
Change in provisions ¹	-612	-156	>100%
Change in working capital ¹	-140	-46	>100%
Other movements	-1	-21	-95%
Net cash flow from operating activities	959	1,277	-25%
Capex²	930	1,205	-23%
Proceeds from real estate	1	2	-50%
Tax recapture E-Plus	-	151	-100%
Free cash flow³	30	225	-87%
Coupon on perpetual hybrid	-67	-34	97%

- Free cash flow € 195m lower y-on-y mainly due to
 - € 429m lower EBITDA, excluding € 451m pension provision release in Q2 '14
 - € 94m less cash from change in working capital, YTD '13 supported by € 167m prepayments made in Q4 '12
- Partly offset by
 - € 275m lower Capex
 - € 40m lower tax paid
- Capex 23% lower y-on-y
 - Lower customer driven investments, incl. phasing out of handset lease
 - Lower mobile and fixed network investments
 - Simplification

1 Excluding changes in deferred taxes

2 Including property, plant & equipment and software

3 Defined as cash flow from operating activities, plus proceeds from real estate, minus Capex and excluding tax recapture E-Plus

Contents

1	Chairman's review	Eelco Blok
2	Group financial review	Steven van Schilfgaarde
3	Group operating review	Eelco Blok
4	Concluding remarks	Eelco Blok

Operating review The Netherlands

Financial review

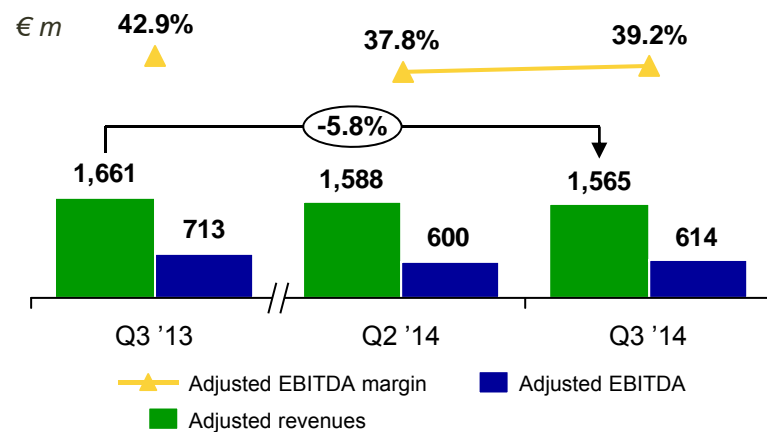

- Adjusted revenues 5.8% lower y-on-y (Q2 '14: -7.6%)
- Adjusted EBITDA 11% lower y-on-y (excl. impact phasing out handset lease) (Q2 '14: -13%)

Good strategic progress

- Simplification resulting in YTD '14 Capex and opex savings ~€ 100m y-on-y
- Continued improvement customer satisfaction

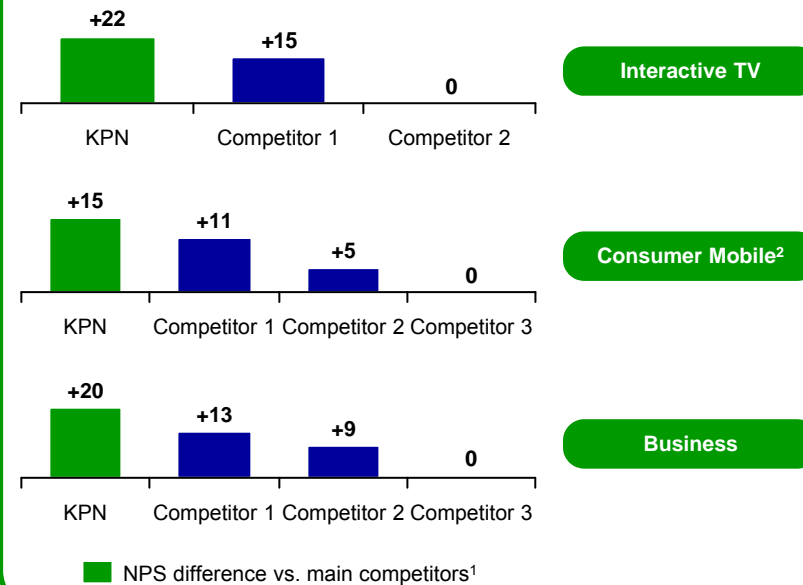

¹ Research TNS, rebased to the lowest score
² KPN score is weighted average over all brands

Consumer - multi play

Fixed-mobile bundles successful

Continued growth triple play

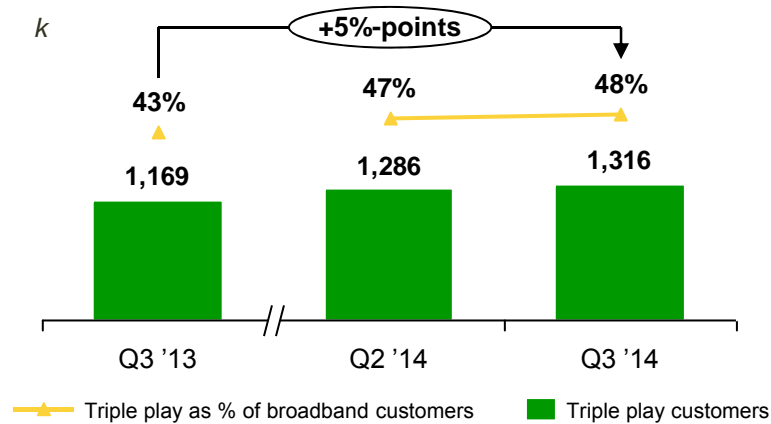

- Continued growth triple play customer base, penetration up 5%-points y-on-y

Strong growth fixed-mobile bundles

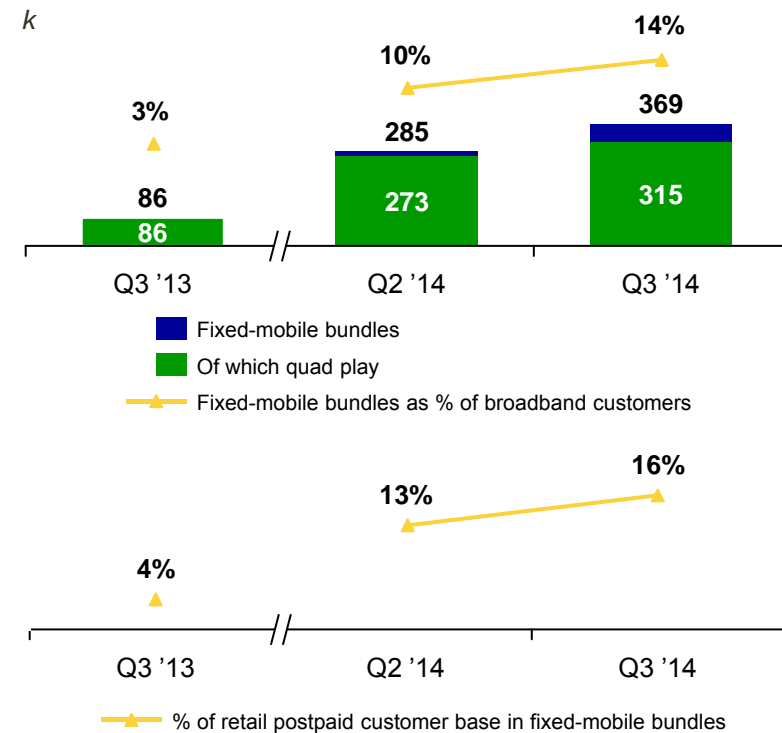

Consumer Residential

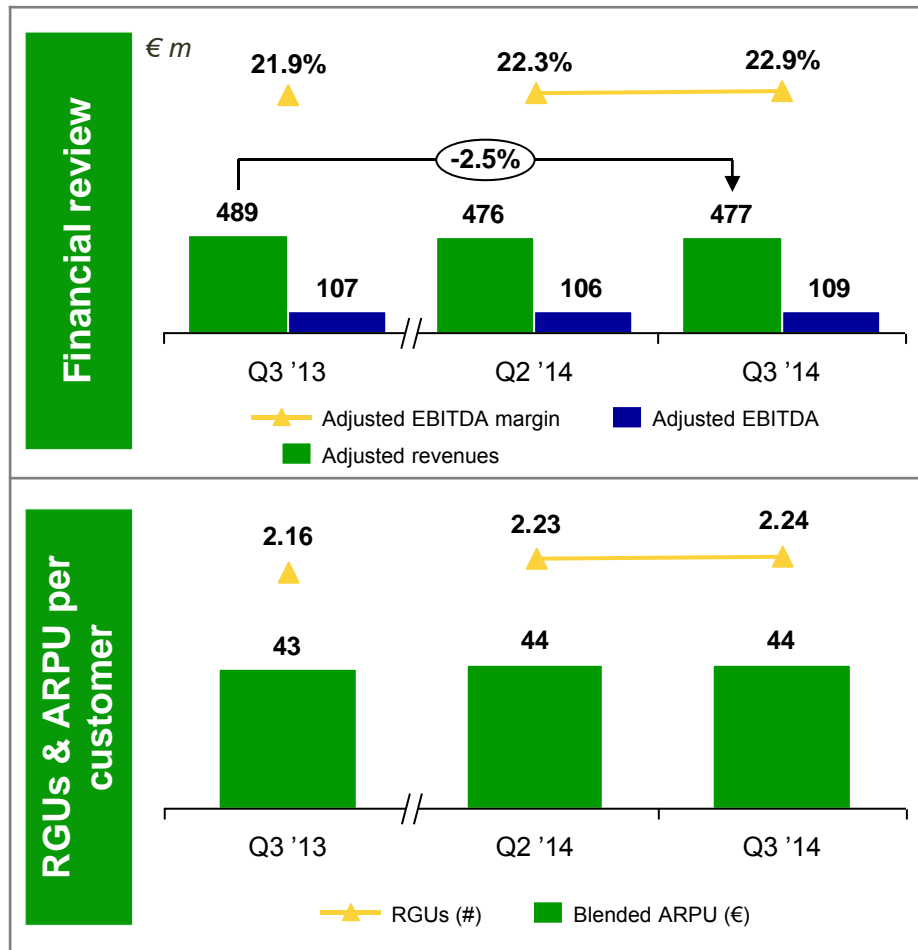

- Adjusted revenues 2.5% lower y-on-y
 - Ongoing decline traditional voice services
 - Increased commercial activities to counter continued promotional activities by competition
- Adjusted EBITDA margin of 22.9% supported by lower personnel costs
- Increasing RGUs per customer driven by strong take-up triple play
- Continued increase ARPU per customer

Consumer Residential (cont'd)

Commercial initiatives successfully supporting RGU trends

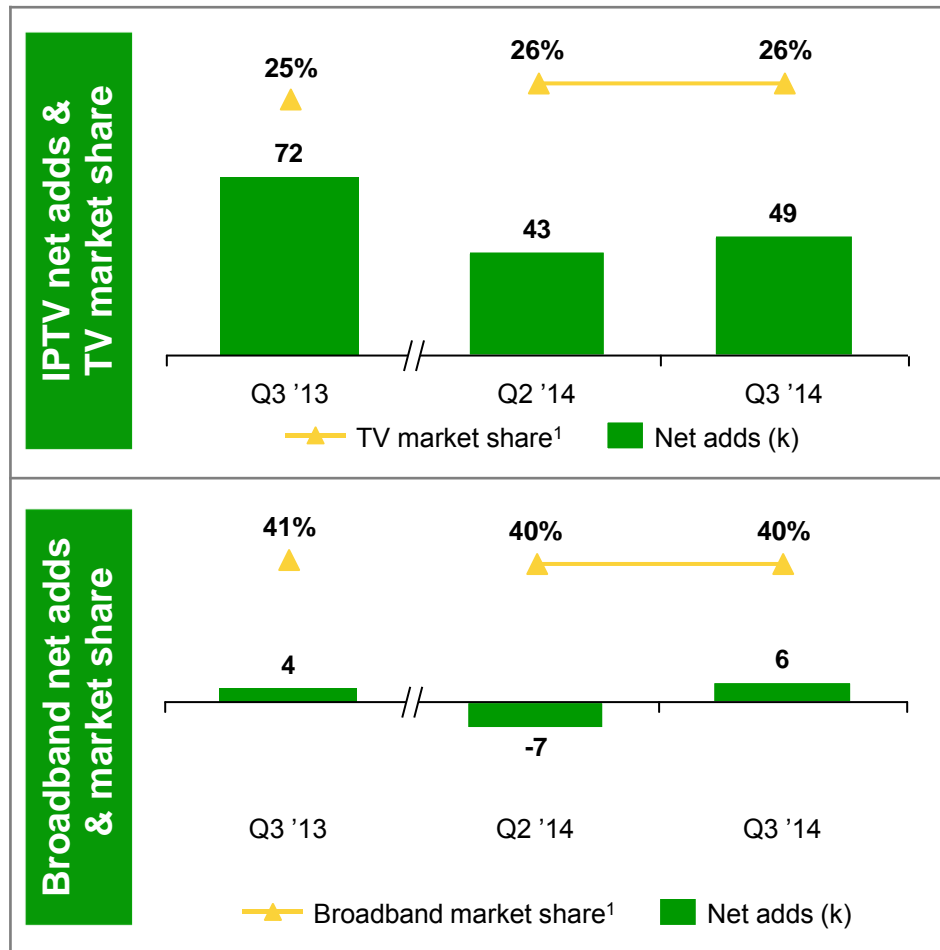

- Commercial initiatives and copper upgrades successfully supporting RGU trends
 - Integrated FttH / copper proposition
 - New KPN and Telfort fixed-mobile bundles
 - Increased promotional activities
 - On track for ~50% coverage of households with 100Mbps end-2014
- Return to growth in broadband, good IPTV net adds
- >1.5 million IPTV customers

1 Source: Telecompaper, management estimates for Q3 '14

Consumer Mobile

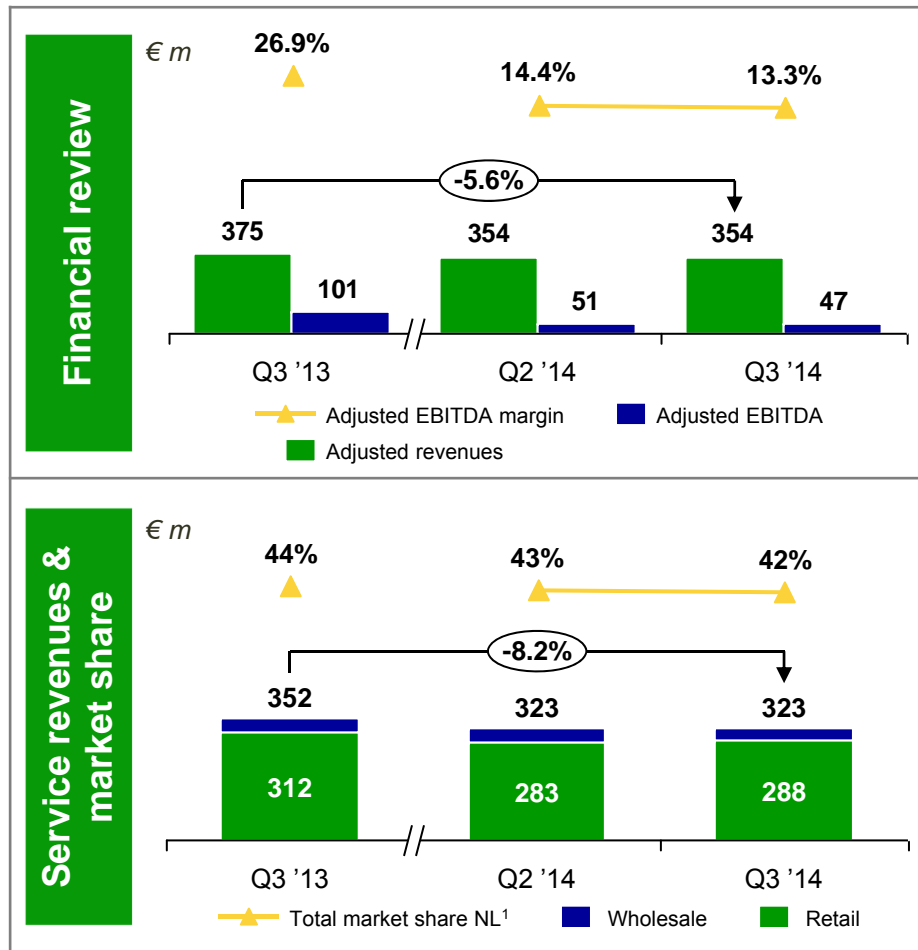

- Underlying service revenue decline of 6.9% y-on-y (Q2 '14: -9.3%)
 - Mainly driven by lower above bundle usage and lower price levels y-on-y
 - Improving trend due to high postpaid net adds supported by lower churn
- Adjusted EBITDA margin lower y-on-y
 - Phasing out handset lease (~€ 21m)
 - Lower service revenues
 - Higher SAC/SRC driven by higher number of new handset subscriptions
- Total Dutch mobile market share somewhat lower at 42%

¹ Total Dutch (Consumer and Business) mobile service revenue market share

Consumer Mobile (cont'd)

Continued high retail postpaid net adds

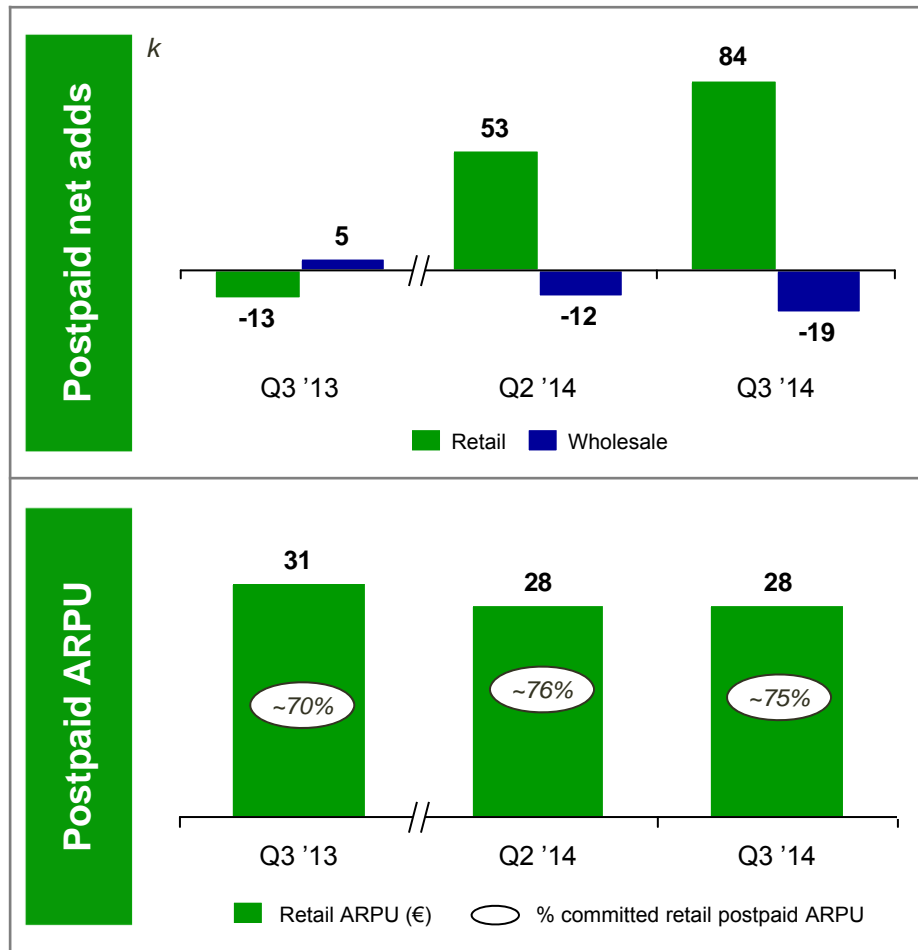

- High retail postpaid net adds of 84k
 - Driven by good performance of KPN brand and no frills brands
- Lower churn across all brands supported by
 - Increased uptake fixed-mobile bundles
 - Nationwide 4G coverage
- 4G uptake continuing, now 1.1m subscribers in Consumer Mobile (Q2 '14: 845k)
- Retail postpaid ARPU stable compared to Q2 '14
- Committed ARPU up 5%-points y-on-y

Business

Challenging market environment impacting financial performance

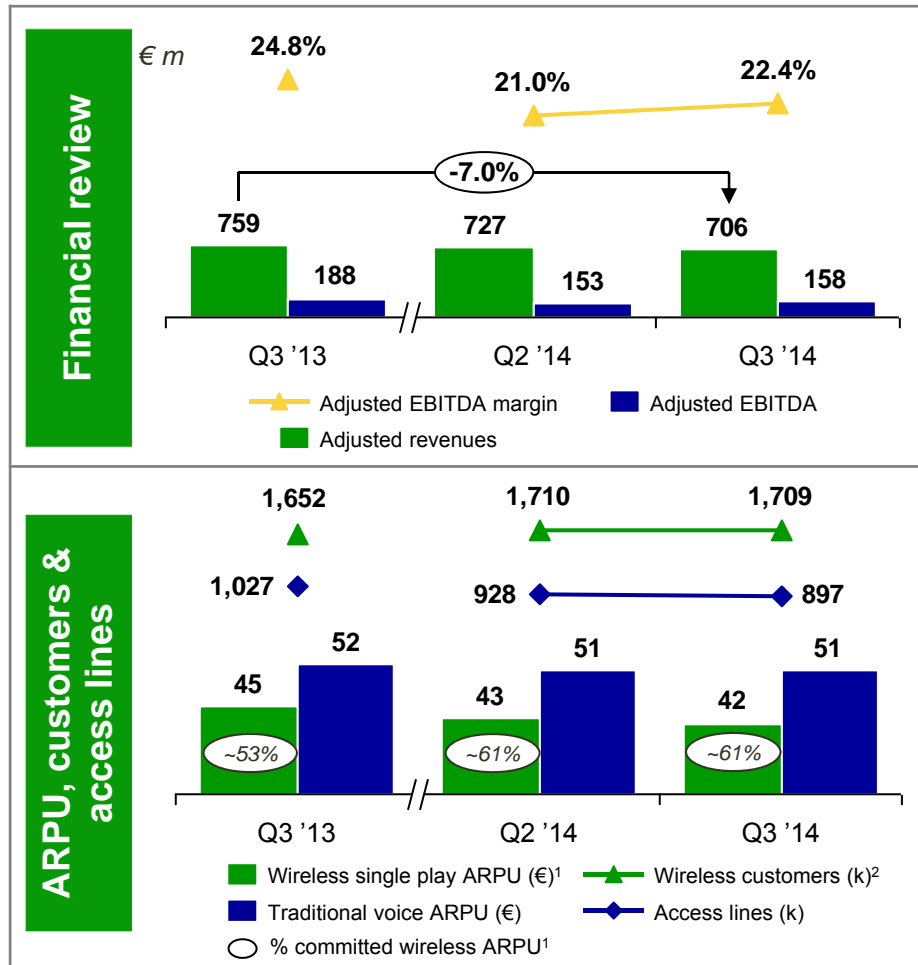

- Adjusted revenues declined 7.0% y-on-y
 - Continued decline of market size driven by customer rationalization and optimization
- Adjusted EBITDA margin at 22.4%
 - Continued decline traditional voice services
 - Higher SAC/revenues to maintain market positions
 - Partly offset by lower personnel expenses and several small positive one-offs
- Decline in access lines driven by continued rationalization and migration towards VoIP
- Stable wireless customer base, ARPU lower
- Committed ARPU increased 8%-points y-on-y

1 Excluding M2M and multi play customers
 2 Excluding M2M

Business (cont'd)

Accelerating cost reduction programs to offset revenue pressure

Initial Simplification benefits

- Further steps to simplify product portfolio, client processes and IT
 - ~€ 10m y-on-y reduction external personnel spend
 - Reduction inbound calls

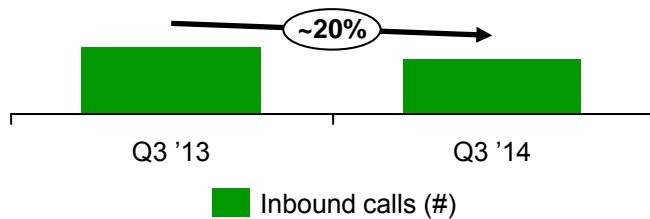

- ~350 FTE reductions YTD '14
 - 400-500 FTE reductions expected FY '14

▶ Additional cost measures to be implemented to offset continued revenue pressure

Good progress 4G & multi play

- Growing 4G customer base, now 612k subscribers (Q2 '14: 525k)

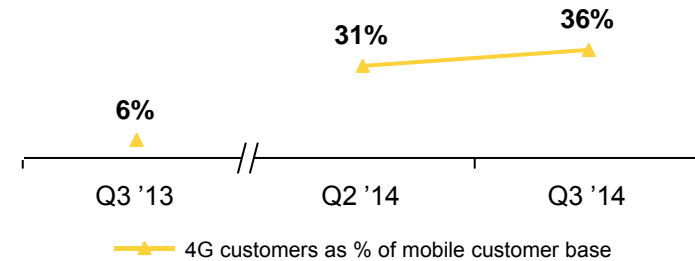

- Growing number of multi play seats

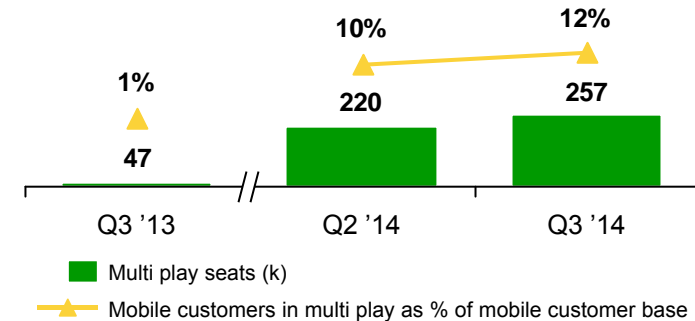

NetCo

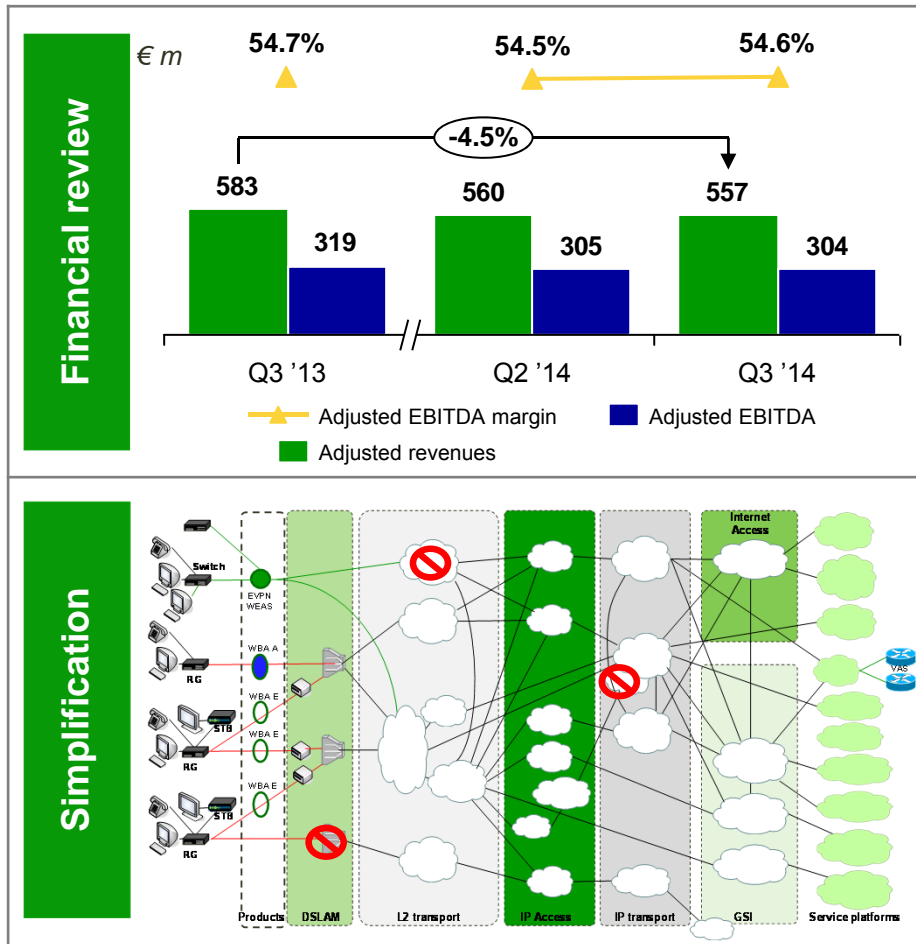

- Adjusted revenues down 4.5% y-on-y
 - Decline traditional services and lower traffic across segments
 - Lower wholesale traffic revenues
- Adjusted EBITDA margin relatively stable at 54.6%
 - Decline of high margin traditional services
 - Partly offset by savings from Simplification
- Good progress to reduce complexity
 - Mobile IP backbone networks phased out, migrated to fixed-mobile converged network
 - Obsolete DSLAMs & Ethernet network phased out

iBasis

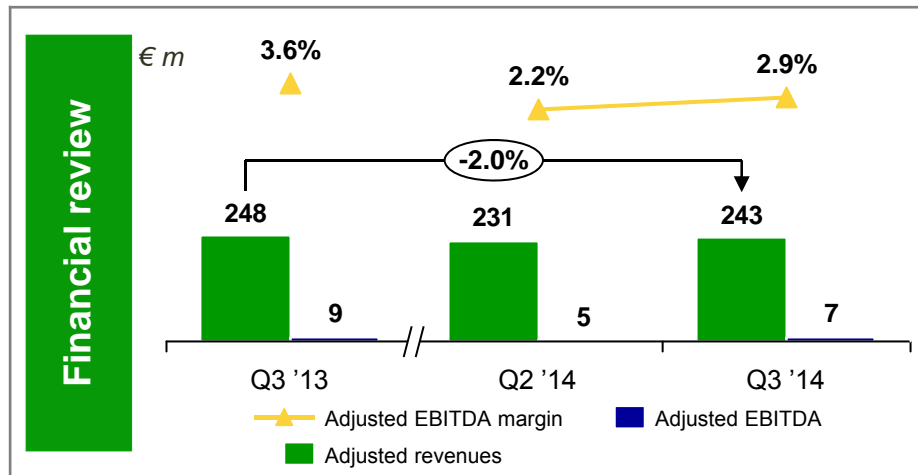

- Adjusted revenues down 2.0% y-on-y
 - Competitive international wholesale traffic market
- Adjusted EBITDA margin at 2.9%
 - Decline of high margin revenues, partly offset by continued cost focus
- Successfully completed first international VoLTE roaming calls together with China Mobile

Belgium

Price, service and network quality leadership

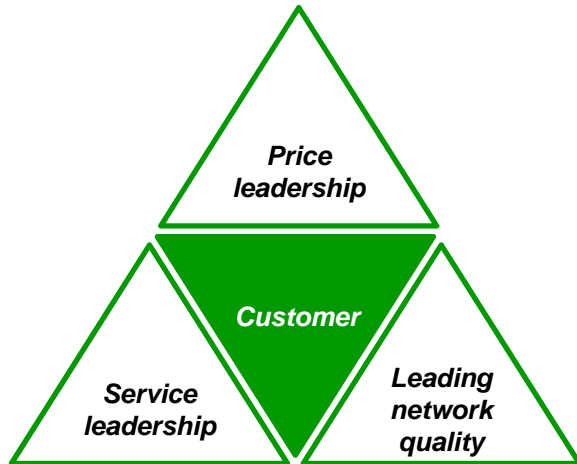

Price leadership¹

% of users recognizing price difference, consider operator the cheapest

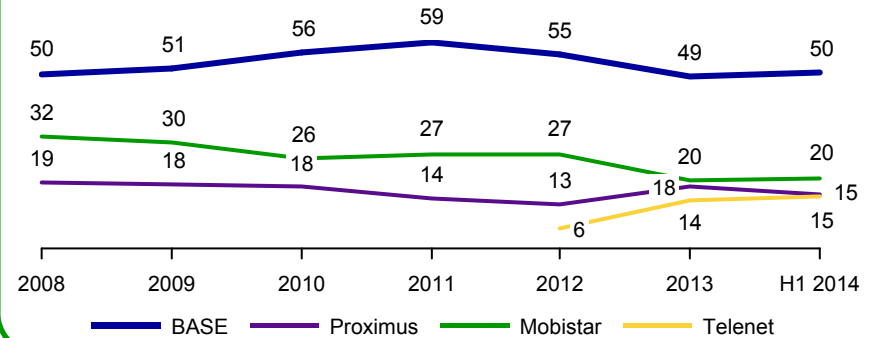

Service leadership²

NPS scores

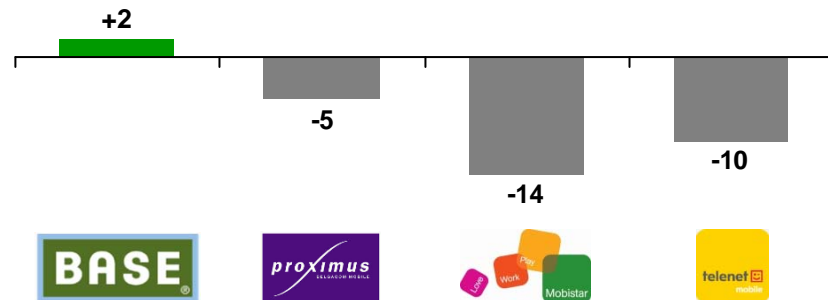

High network quality

- Ongoing network investments, 4G coverage ~63% end Q3 '14



1 Company research
2 Company research June 2014

Belgium (cont'd)

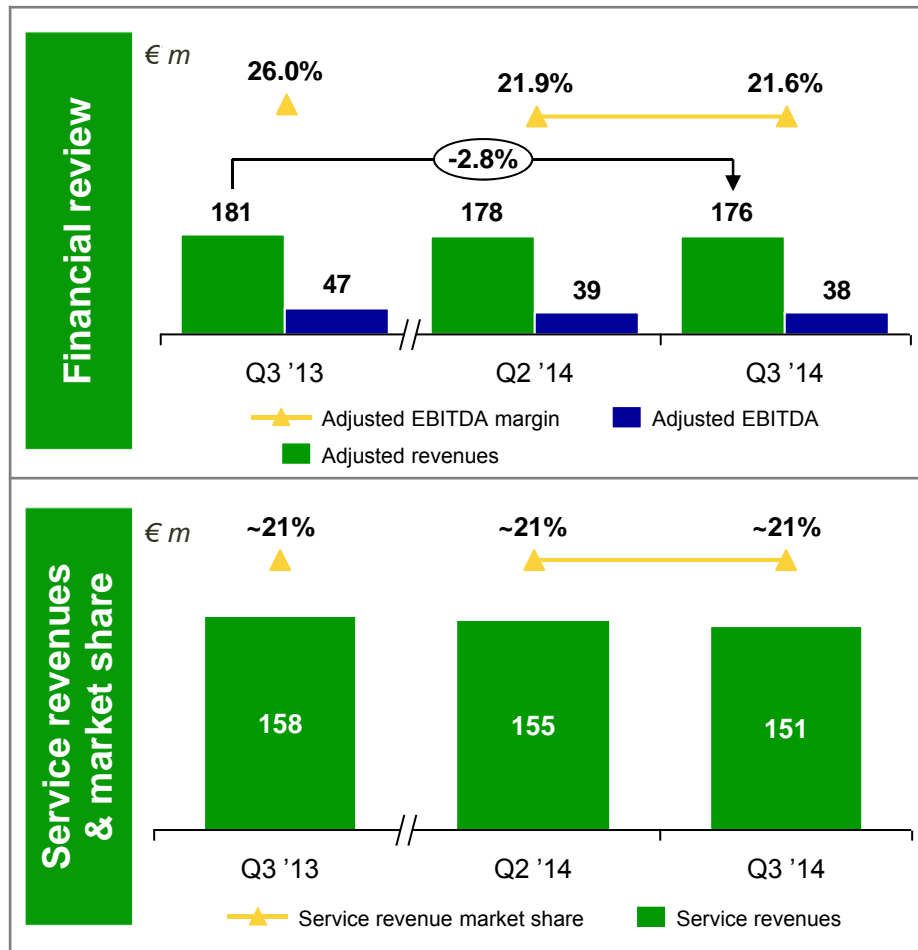

- Underlying service revenue decline 1.3% y-on-y (Q2 '14: -1.9%) in stabilizing market
 - Postpaid service revenue growth, prepaid remains under pressure
 - Continued tariff optimization by customers
- Adjusted EBITDA margin at 21.6%
 - Higher traffic costs driven by flat fee propositions
 - Provision for Walloon region site taxes (€ 2m)
- Streamlining distribution model, 27 shops closed in September 2014
- Continued strong data revenue growth of >60% y-on-y

Belgium (cont'd)

Continued good postpaid net adds

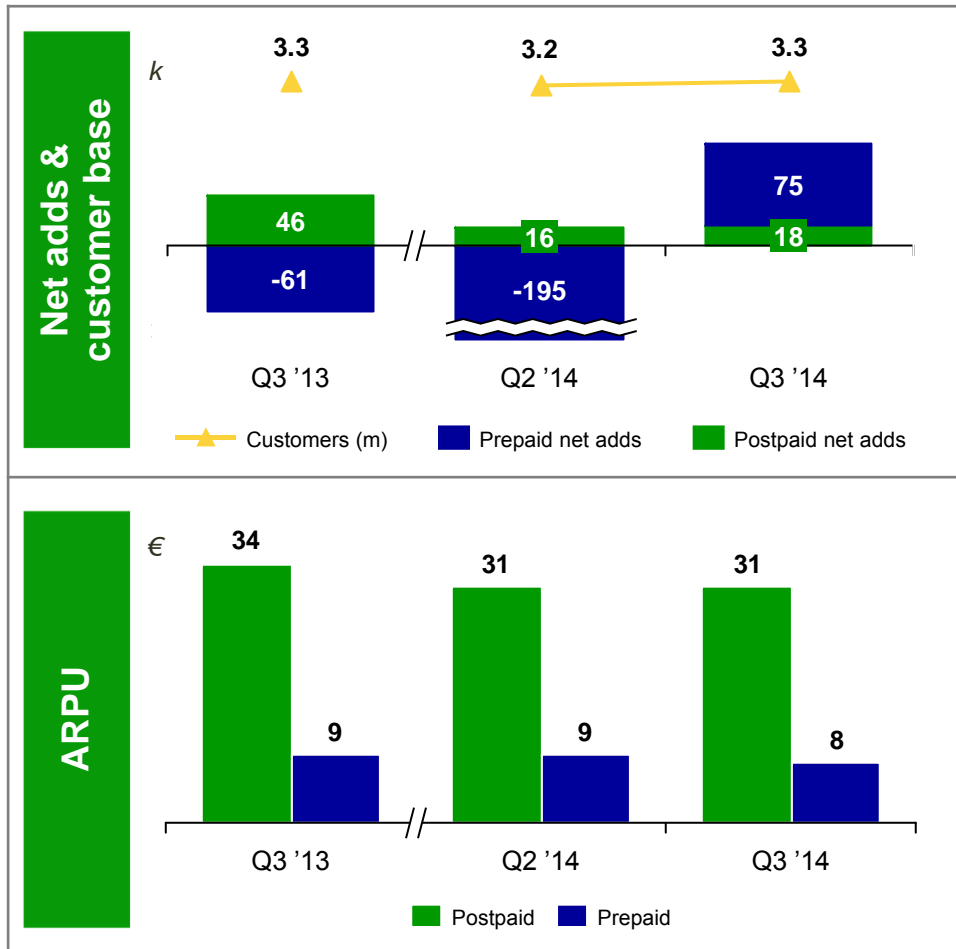

- Continued good postpaid net adds
- Prepaid net adds of +75k driven by strong performance wholesale partners
- Postpaid ARPU stabilizing

Contents

1	Chairman's review	Eelco Blok
2	Group financial review	Steven van Schilfgaarde
3	Group operating review	Eelco Blok
4	Concluding remarks	Eelco Blok

Concluding remarks

- Continued customer base growth 4G, IPTV and multi play in The Netherlands
- Price, service and network quality leadership in Belgium
- Simplification program well on track
- Financial performance gradually improving
- E-Plus sale leads to solid financial profile, dividend payments recommenced
- Cash proceeds increasing financial flexibility, bond tender to reduce gross debt

Q3 2014 - Information Pack

For further information please contact

KPN Investor Relations

+31 70 44 60986

ir@kpn.com

www.kpn.com/ir



Contents

1	KPN ADR program
2	Group results analysis
3	Debt overview
4	Regulation & Spectrum
5	Fixed infrastructure & Reggefiber
6	Telefónica Deutschland stake

KPN ADR program

KPN has a sponsored Level 1 ADR program

ADR program	
Bloomberg ticker	KKPNY
Trading platform	Over-the-counter (OTC)
CUSIP	780641205
Ratio	1 ADR : 1 Ordinary Share
Depository bank	Deutsche Bank Trust Company Americas
Depository bank contact	Begonia Roberts
ADR broker helpline	+1 212 250 9100 (New York) +44 207 547 6500 (London)
E-mail	adr@db.com
ADR website	www.adr.db.com
Depository bank's local custodian	Deutsche Bank, Amsterdam

Contents

1	KPN ADR program
2	Group results analysis
3	Debt overview
4	Regulation & Spectrum
5	Fixed infrastructure & Reggefiber
6	Telefónica Deutschland stake

Analysis of adjusted results YTD '14

Impact incidentals (no incidentals in Q3 '14 and Q3 '13)

Revenues (€ m)		YTD '14	YTD '13
Sale of fixed assets (hardware)	Business	5	-
Change in provision	NetCo	17	-6
Book gain sale IS&P	Business	-	23
Adjustment deferred revenues	Germany, Consumer Residential, Consumer Mobile	-	49
KPN Group		22	66
<i>Of which discontinued operations</i>		-	29
KPN Group continuing operations		22	37

EBITDA (€ m)		YTD '14	YTD '13
Volume discount hardware	Germany	8	-
Change in provision	NetCo	17	4
Sale of fixed assets (hardware)	Business	5	-
Release of pension provision	Other	451	-
Adjustment deferred revenues	Germany, Consumer Residential, Consumer Mobile	-	49
Book gain sale IS&P	Business	-	23
Release of asset retirement obligation	NetCo, Germany	-	42
Release accruals	NetCo	-	7
KPN Group		481	125
<i>Of which discontinued operations</i>		8	66
KPN Group continuing operations		473	59

Restructuring costs

€ m	Q3 '14	Q3 '13	YTD '14	YTD '13
Germany (incl. discontinued operations)	-6	1	-12	6
Belgium	-	-	-3	-
Mobile International (incl. discontinued operations)	-6	1	-15	6
Consumer Mobile	-	-	-1	-5
Consumer Residential	-1	-4	-7	-16
Business	-5	-5	-18	-24
NetCo	-2	-2	-3	-7
Other	1	-7	-2	-32
The Netherlands	-7	-18	-31	-84
Other	-10	-1	-19	-5
KPN Group	-23	-18	-65	-83
<i>Of which discontinued operations</i>	-6	1	-12	6
KPN Group continuing operations	-17	-19	-53	-89

Impact regulation

€ m	Q3 '14		Q3 '13	
	Revenues	EBITDA	Revenues	EBITDA
Germany (incl. discontinued operations)	-20	-17	-42	-22
Belgium	-5	-4	-11	-7
Mobile International (incl. discontinued operations)	-25	-21	-53	-29
Consumer Mobile	-5	-	-7	-3
<i>Of which: Mobile Wholesale</i>	-	-	-	-
Business	-6	-4	-10	-7
NetCo	-1	-	-2	-
The Netherlands	-12	-4	-19	-10
KPN Group	-37	-25	-72	-39
<i>Of which discontinued operations</i>	-20	-16	-42	-22
KPN Group continuing operations	-17	-9	-30	-17

Operating expenses

€ m	Q3 '14	Q3 '13	%
Employee benefits	309	307	0.7%
Cost of materials	171	146	17%
Work contracted out and other expenses	793	782	1.4%
Own work capitalized	-17	-17	flat
Other operating expenses ¹	89	119	-25%
Depreciation ²	294	319	-7.8%
Amortization ²	146	143	2.1%
Total operating expenses from continuing operations	1,785	1,799	-0.8%

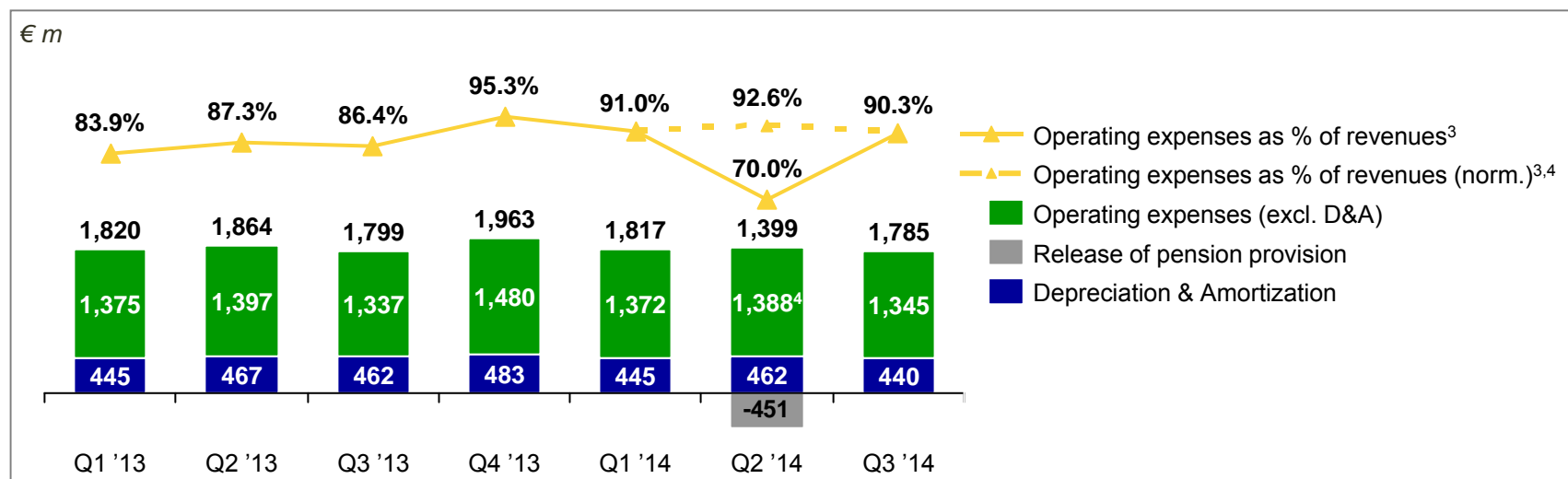

- 1 Including restructuring costs
- 2 Including impairments (if any)
- 3 As % of revenue excluding other income
- 4 Excluding release of pension provision in Q2 2014

Operating expenses - analysis

Employee benefits & Cost of materials

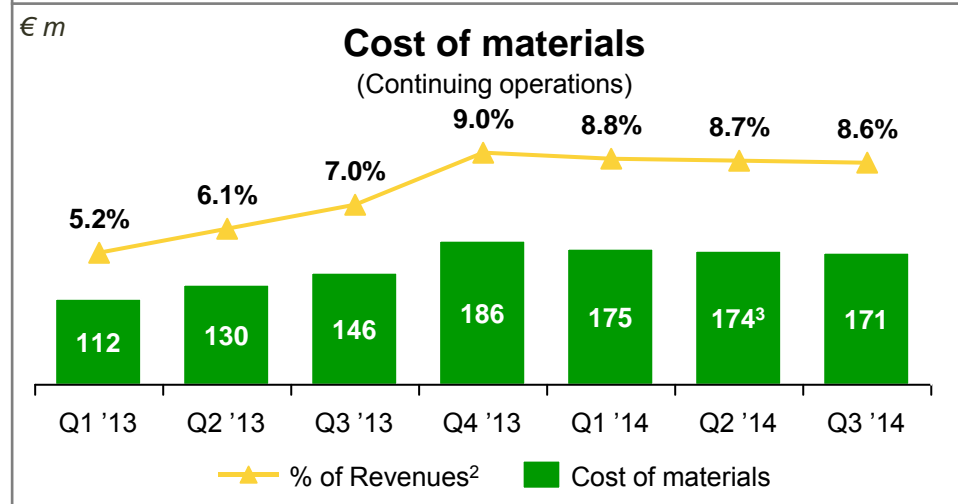
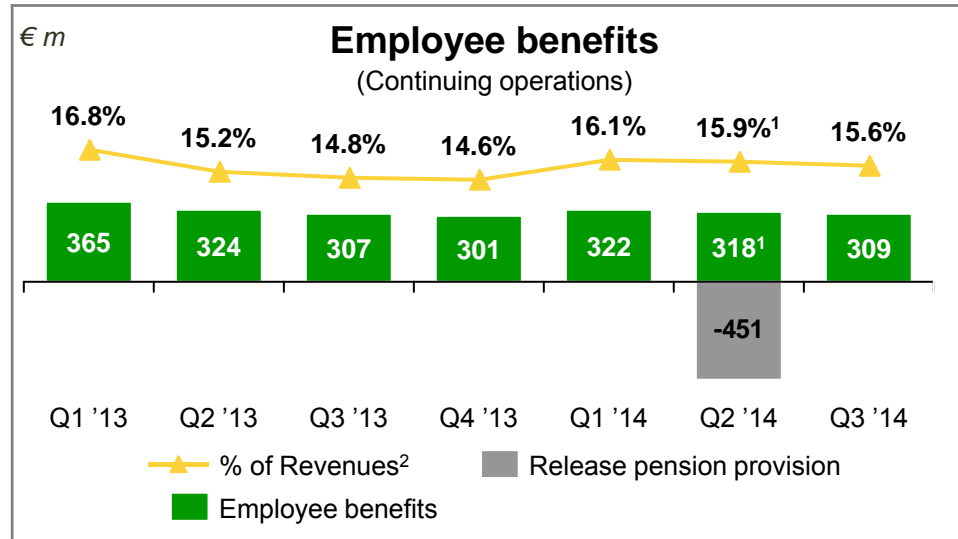

Y-on-Y increase

- Release of provisions for several incentive schemes in Q3 '13

Q-on-Q decrease

- Lower cost as a result of FTE reduction program
- Release of provision for holiday allowance

Y-on-Y increase

- Higher costs due to phasing out of handset lease at all brands at Consumer Mobile
- High SAC/SRC at Consumer Mobile due to higher number of new handset subscriptions

Q-on-Q decrease

- Lower hardware costs at Business

1 Excluding release of pension provision in Q2 2014
 2 As % of revenue excluding other income
 3 Restated due to better insights

Operating expenses - analysis

Work contracted out & Other

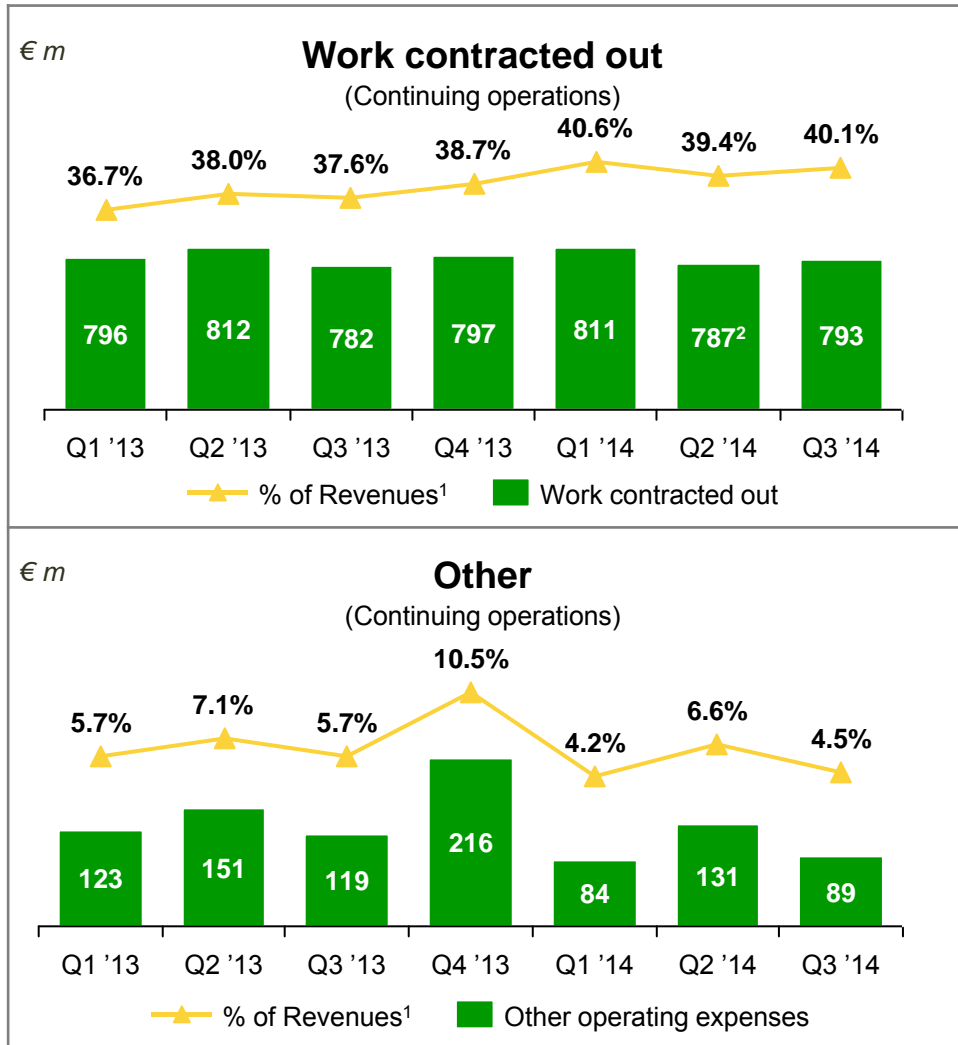

1 As % of revenue excluding other income
2 Restated due to better insights

Y-on-Y increase

- Higher content costs at Consumer Residential
 - Higher FttH activation costs at NetCo
- Partly offset by
- Lower IT costs due to Simplification program at NetCo
 - Less external personnel

Q-on-Q increase

- Higher traffic costs at iBasis related to higher external revenues

Y-on-Y and Q-on-Q decrease

- Lower costs due to Simplification
- Lower marketing spend
- Lower restructuring costs

Operating expenses - analysis

Depreciation & Amortization

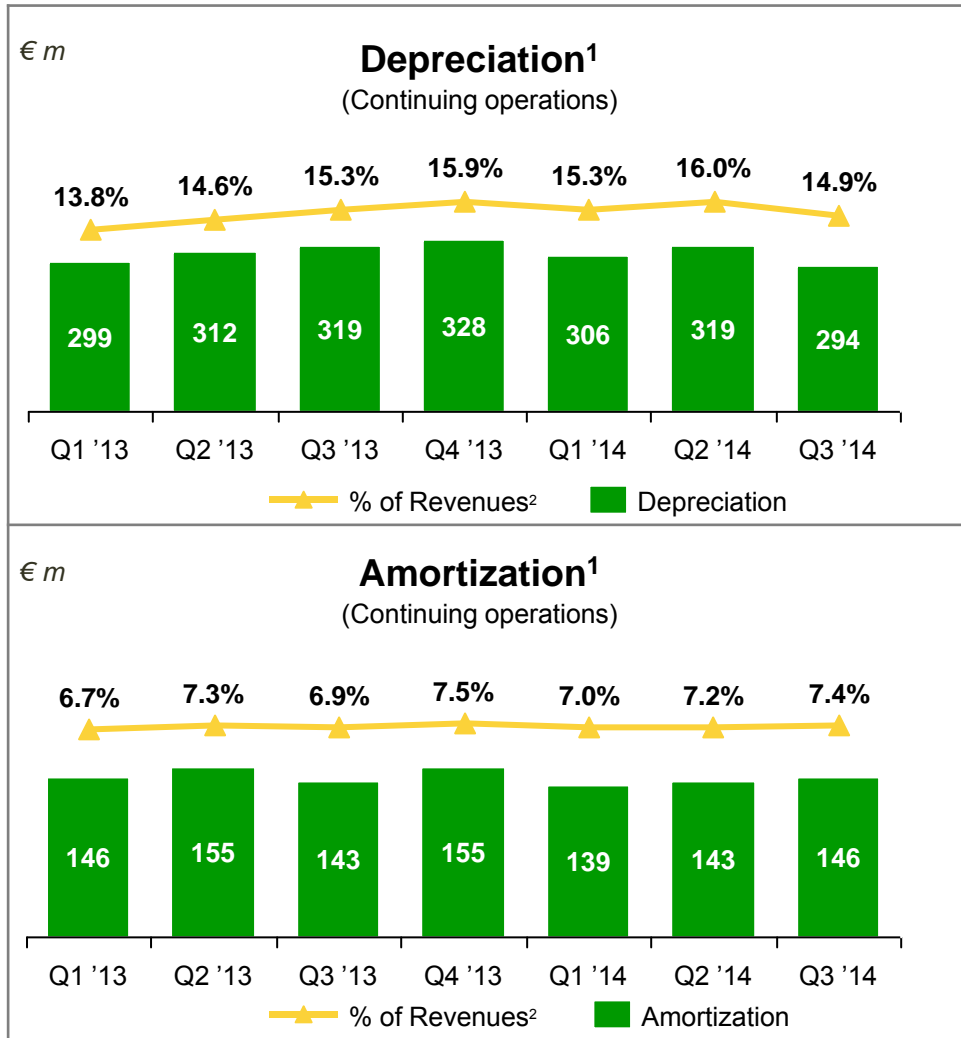

Y-on-Y decrease

- Lower depreciation due to phasing out of handset lease at all brands at Consumer Mobile

Q-on-Q decrease

- Lower depreciation due to phasing out of handset lease at all brands at Consumer Mobile
- Lower depreciation of hardware at NetCo due to reclassification in Q2 2014

Y-on-Y increase

- Higher amortization of software

Q-on-Q increase

- Higher amortization of software

1 Including impairments, if any
 2 As % of revenue excluding other income

The Netherlands - operating expenses

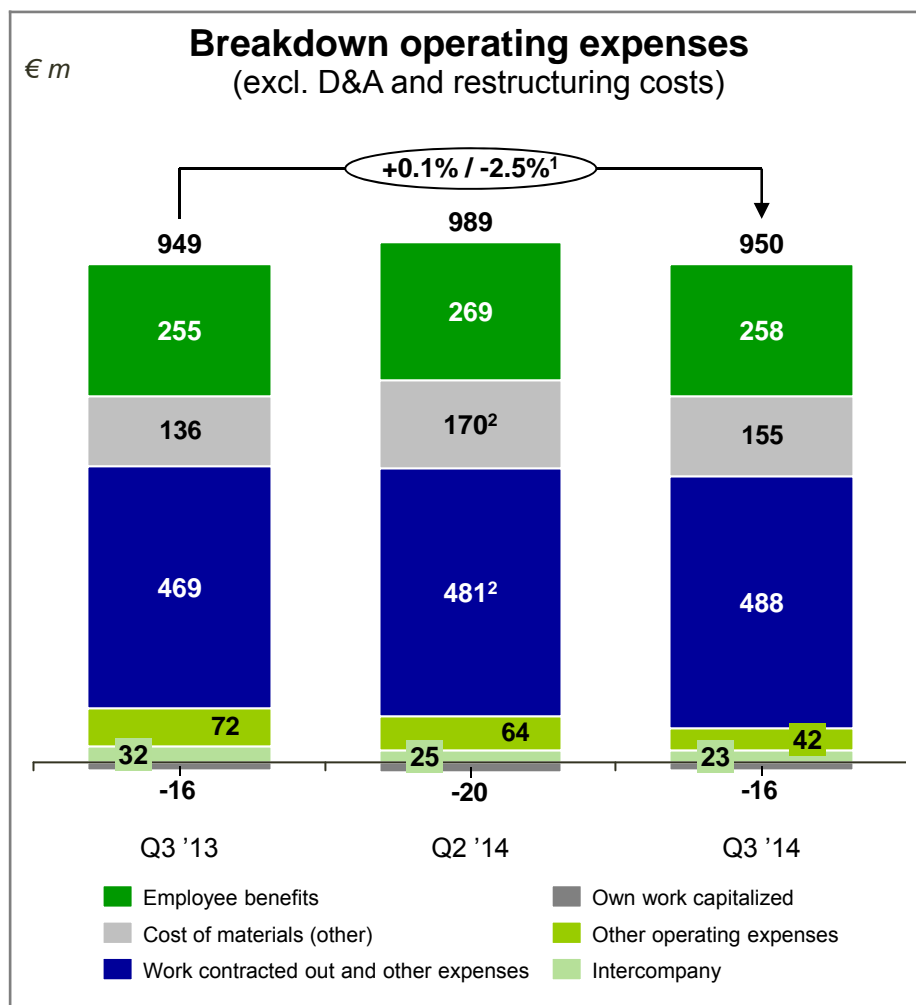

1 Excluding impact of phasing out handset lease
2 Restated due to better insights

- Operating expenses (excl. D&A, restr. costs and impact phasing out handset lease) down 2.5% y-on-y
- Employee benefit costs increased 1.2% y-on-y due to release of provisions for several incentive schemes in Q3 '13
- Cost of materials (excl. impact phasing out handset lease) decreased by 3.7% y-on-y
- Work contracted out increased 4.1% y-on-y
 - Higher content costs at Consumer Residential
 - Higher FttH activation costs at NetCo
 Partly offset by
 - Lower IT cost due to Simplification program at NetCo
 - Less external personnel
- Simplification program supporting further opex reduction in coming years

Dutch wireless disclosure

	Q3 '14	Q3 '13	%
Service revenues (€ m)	533	587	-9.2%
- Consumer retail	288	312	-7.7%
- Business ¹	205	229	-10%
- Other ²	40	46	-13%
SAC/SRC per subscriber (€)			
- Consumer retail ³	190	172	10%
- Business	266	244	9.0%

1 Includes partial allocation of multi play revenues to mobile service revenues

2 Includes amongst others Consumer Mobile wholesale and visitor roaming revenues at NetCo

3 Including handset subsidies, commissions, SIM costs and capitalization of handsets corrected for residual value

Tax

Fiscal units (€ m)	P&L		Cash flow	
	Q3 '14	Q3 '13	Q3 '14	Q3 '13
The Netherlands	-10	-12	-14 ¹	-81 ²
Germany	17	-102	-2	1
Belgium	1	-	-	-
Other	-3	-2	-	-1
Total reported tax (incl. discontinued operations)	5	-116	-16	-81
<i>Of which discontinued operations</i>	16	-101	-2	1
Reported tax continuing operations	-11	-15	-14	-82
<i>Effective tax rate continuing operations</i>	-17.7%	14.7%		

- In Q3 '14, the effective tax rate for continuing operations is influenced by a changing mix of taxable results in the various countries and the increase in the option liability for Reggefiber
- Q3 '14 cash outflow in The Netherlands relates to settlement of tax payables of previous years, which is expected to occur in the coming quarters as well
- For the 2014-2016 period, the effective tax rate, excluding one-off effects³, is expected to be ~20%
- Deferred tax asset resulting from E-Plus sale increased by € 106m to € 1.2bn, limited tax cash out in The Netherlands in the coming years

1 Relating to tax payments for period prior to 2014

2 Including tax recapture E-Plus

3 Excluding effects of, amongst others, settlements with tax authorities, impairments, revaluations

Contents

1	KPN ADR program
2	Group results analysis
3	Debt overview
4	Regulation & Spectrum
5	Fixed infrastructure & Reggefiber
6	Telefónica Deutschland stake

Debt summary

€ bn	Q3 '14	Q2 '14	%
Nominal debt	12.84	12.80	0.03%
Eurobonds	9.43	9.43	-
Global bonds	0.76	0.76	-
Hybrid bonds	2.03	2.03	-
Financial leases and other loans	0.62	0.58	6.9%
Adjustments to nominal debt	-1.02	-1.02	-
Equity credit hybrid bonds	-1.01	-1.01	-
Cash collateral on derivatives	-0.01	-0.01	-
Gross debt¹	11.82	11.78	0.3%
<i>Of which short-term</i>	<i>1.34</i>	<i>1.31</i>	<i>2.3%</i>
Net cash & cash equivalents	1.50	1.33	13%
Cash & cash equivalents	1.50	1.53	-2.0%
Bank overdraft	-	-0.20	-100%
Net debt²	10.32	10.45	-1.2%

1 Gross debt defined as the nominal value of interest bearing financial liabilities, excluding derivatives and related collateral, representing the net repayment obligations in Euro, taking into account 50% of the nominal value of the hybrid capital instruments

2 Net debt defined as gross debt less net cash and short-term investments

Debt portfolio

Breakdown of € 12.8bn nominal debt¹ including hybrid bonds

Breakdown nominal debt¹ (total €12.8bn)

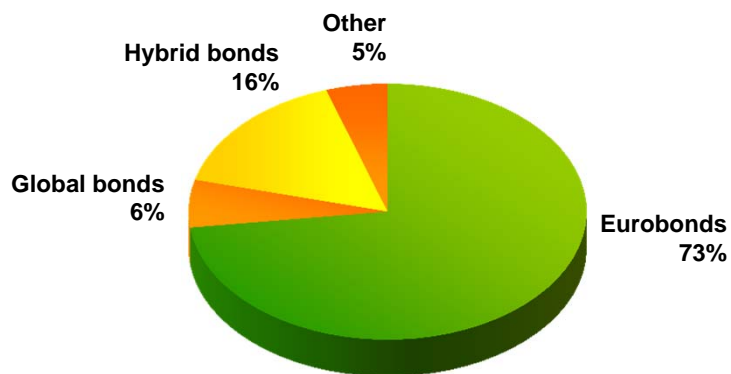

Nominal debt by currency

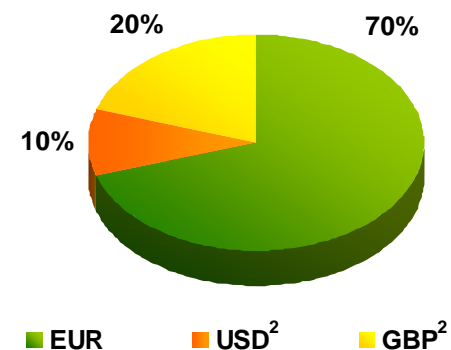

€ bn

Bond redemption profile

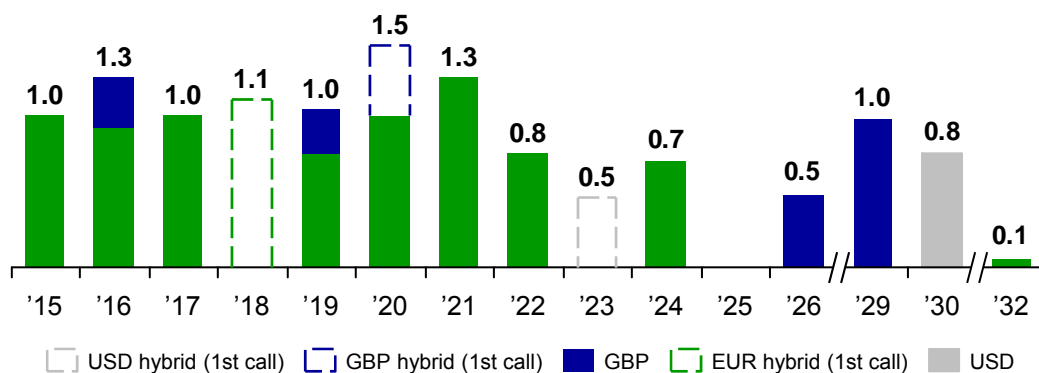

Fixed vs. floating interest

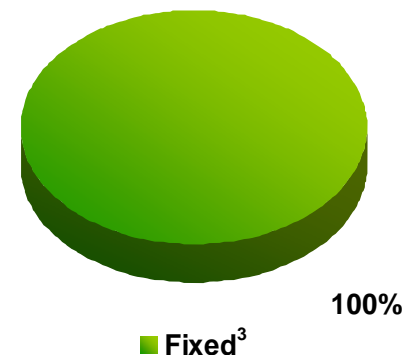

1 Based on the nominal value of interest bearing liabilities after swap to EUR, including EUR 1.1bn hybrid bond, GBP 400m hybrid bond and USD 600m hybrid bond

2 Foreign currency amounts hedged into EUR

3 Excludes bank overdrafts

Treatment of hybrid bonds

KPN & Credit rating agencies

- Each tranche of the hybrid bonds is recognized as 50% equity and 50% debt by the rating agencies
- Definition of KPN net debt includes: *'[...] taking into account 50% of the nominal value of any hybrid capital instrument'*
 - Hybrid bonds are part of KPN's bond portfolio
 - Independent of IFRS classification
 - In line with treatment by credit rating agencies

IFRS

- EUR tranche is a perpetual, accounted for as equity
 - Coupon payments treated as equity distribution, hence not expensed through P&L, not included in FCF, but in financing cash flow^{1,2}
- GBP and USD tranche have 60 years specified maturity, accounted for as financial liability
 - Coupon payments treated as regular bond coupon, hence expensed through P&L, included in FCF

Tranche	Nominal (swapped to EUR)	KPN net debt	Maturity	Rates (swapped) ¹	IFRS principal	IFRS coupon
EUR 1.1bn 6.125%	€ 1,100m	€ 550m	Perpetual (non-call 5.5)	6.125%	Equity	Financing cash flow ² (not incl. in FCF)
GBP 0.4bn 6.875%	€ 460m	€ 230m	60 years (non-call 7)	6.777%	Liability	Interest paid (incl. in FCF)
USD 0.6bn 7.000%	€ 465m	€ 233m	60 years (non-call 10)	6.344%	Liability	Interest paid (incl. in FCF)
Total	€ 2,025m	€ 1,013m				

1 EUR tranche had short first coupon payment (0.5 years was payable in September 2013), annual coupon payments in September thereafter; USD tranche has semi-annual coupon payments (March / September); GBP tranche has annual coupon payments in March

2 Cash flow item 'Paid coupon perpetual hybrid bonds'

Contents

1	KPN ADR program
2	Group results analysis
3	Debt overview
4	Regulation & Spectrum
5	Fixed infrastructure & Reggefiber
6	Telefónica Deutschland stake

Regulation

MTA rates across the Group

NL	<ul style="list-style-type: none"> ACM decision to base MTA rates on 'pure BULRIC' of € 1.019 cent per minute as of 1 September 2013 is under appeal (Court announced prejudicial questions to European Court of Justice) Dutch Court suspended ACM decision and mandated interim rates based on 'plus BULRIC' of € 1.861 cent per minute 							
	€ ct / min	Until 7 July '10	7 July '10	Sep '10	Jan '11	Sep '11	Sep '12	Sep '13
	MTA rate	7.00	5.60	5.60	4.20	2.70	2.40	1.861
BE	<ul style="list-style-type: none"> On 24 September 2014, the Court of Appeal of Brussels annulled BIPT decision of 29 June 2010 for procedural reasons, but decided that the effects of the Decision will be maintained until 30 June 2015 BIPT new tariffs setting (mid 2015 and onwards) in progress 							
	€ ct / min	Until Aug '10	Aug '10	Jan '11	Jan '12	Jan '13		
	MTA rate	11.43	5.68	4.76	2.92 ¹	1.08 ¹		

¹ After indexation the MTA rates applicable as of January 2012 and January 2013 are calculated at € ct / min 3.11 and € ct / min 1.18 respectively

Unbundling tariffs

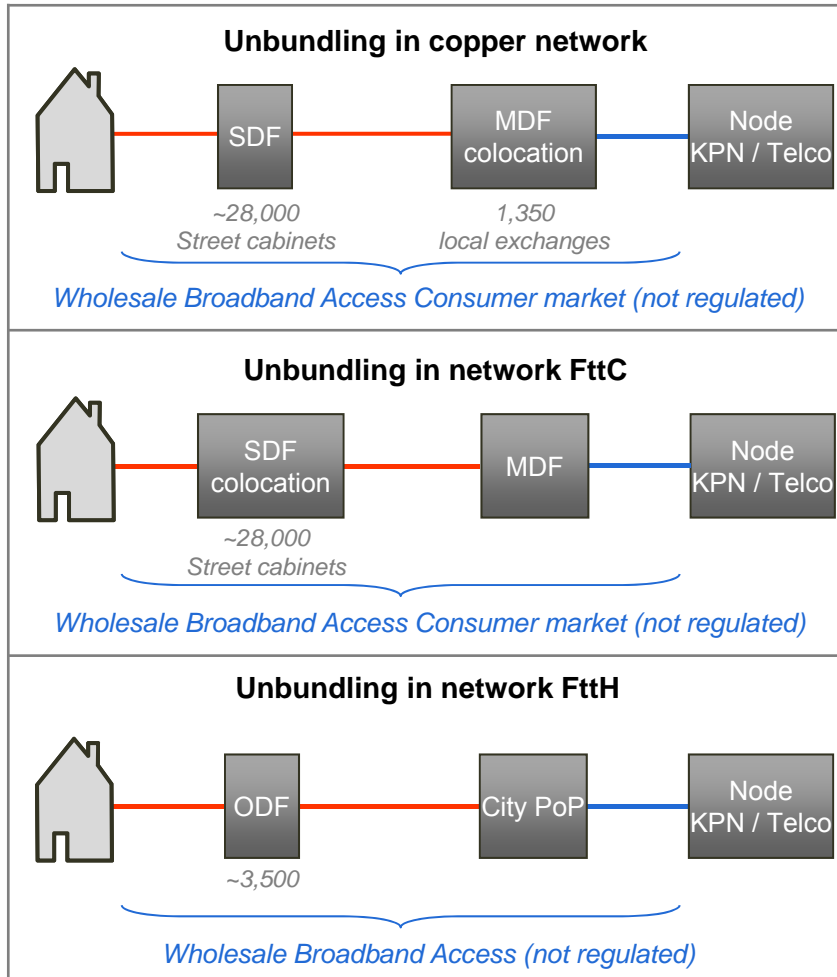

Category	Monthly tariff
Line sharing (LLU)	€ 0.11 / line
Fully unbundled (LLU)	€ 7.79 / line
MDF collocation	€ 946.98 footprint / year
Wholesale Broadband Access ¹	€ 5.32 / line shared € 13.00 / line non-shared

Category	Monthly tariff
Line sharing (SLU)	€ 7.03 / line
Fully unbundled (SLU)	€ 7.03 / line
SDF collocation	€ 5.64 / per unit One-off € 516.23 / per unit
Wholesale Broadband Access ¹	€ 5.32 / line shared € 13.00 / line non-shared

Category	Monthly tariff
Fully unbundled (ODF FttH)	€ 14.23 - € 18.09 / line
ODF FttH collocation	≤ € 548 / month / per Area Pop One-off ≤ € 3,289 / per Area Pop
ODF FttH Backhaul	≤ € 657 / month
Wholesale Broadband Access FttH ²	€ 26.38 - € 45.00 non-shared

— Regulated — Not regulated

1 List prices excluding PVC/VLAN tariffs
2 List prices including PVC/VLAN tariffs

Spectrum in The Netherlands

Current status

800MHz Paired	Tele2 2*10	VOD 2*10	KPN 2*10						2*30
900MHz Paired	VOD 2*10	KPN 2*10	T-Mob 2*15						2*35
1.8GHz Paired	KPN 2*20		VOD 2*20	T-Mob 2*30					2*70
1.9GHz Unpaired	T-Mob 10	KPN 5	VOD 5.4	T-Mob 14.6					1*35
2.1GHz Paired	VOD 2*14.6		KPN 2*14.8	T-Mob 2*10	KPN 2*5	VOD 2*5	T-Mob 2*10		2*59.4
2.6GHz Unpaired	T-Mob 25	KPN 30	Tele2 5						1*60
2.6GHz Paired	VOD 2*10	Ziggo4 2*20	T-Mob 2*5	KPN 2*10	Tele2 2*20				2*65
Total	KPN 174.6MHz		VOD 144.6MHz	T-Mob 189.6MHz		Tele2 65MHz	Ziggo4 40MHz		614MHz

Spectrum in Belgium

Current status

800MHz Paired	BASE 2*10	Belgacom 2*10	Mobistar 2*10	2*30	
900MHz ¹ Paired	BASE 2*10	Belgacom 2*12	Mobistar 2*12	2*34	
1.8GHz ² Paired	BASE 2*23.4	Belgacom 2*23.4	Mobistar 2*23.4	2*63.6	
2.1GHz Paired	Belgacom 2*15	BASE 2*14.8	Mobistar 2*14.8	2*44.6	
2.1GHz Unpaired	B 5	M 5	B 5	1*15	
2.6GHz Paired	Belgacom 2*20	BASE 2*15	Mobistar 2*20	2*55	
2.6GHz Unpaired	BUCD 45			1*45	
Total	Belgacom 160.6MHz	BASE 148.6MHz	Mobistar 160.2MHz	BUCD 45MHz	514.4MHz

- 1 As of 27 November 2015, the 900MHz spectrum will be divided as follows: BASE Company (2*10.2), Mobistar (2*11.8), Belgacom (2*12.2)
- 2 As per publication of a BIPT council decision on division of the 1,800MHz spectrum on 23 July 2014, BASE Company, Belgacom and Mobistar have 2*23.4MHz. As of April 2015 (exact timing to be confirmed by BIPT), BASE Company, Belgacom and Mobistar will each have 2*24.8MHz available in the 1800MHz band

Contents

1	KPN ADR program
2	Group results analysis
3	Debt overview
4	Regulation & Spectrum
5	Fixed infrastructure & Reggefiber
6	Telefónica Deutschland stake

Infrastructure

Deploying mix of technologies going forward

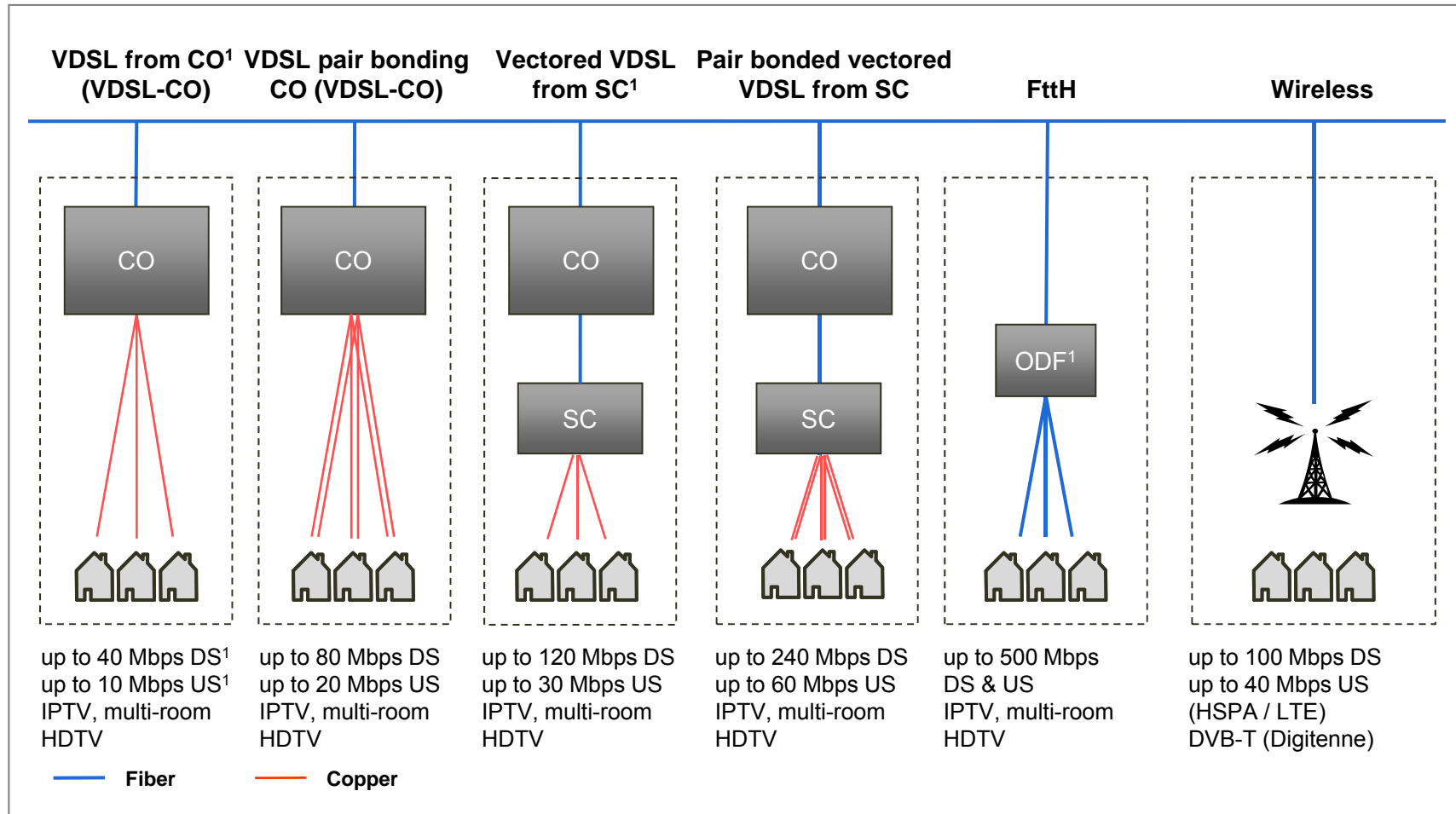

¹ Abbreviations: CO: Central Office; SC: Street Cabinet; ODF: Optical Distribution Frame; DS: Download Speed; US: Upload Speed

Roadmap to Reggefiber consolidation

Option structure

	Option I ¹	Option II ³	Option III
Ownership stake	<ul style="list-style-type: none"> Additional 10% 51% ownership 	<ul style="list-style-type: none"> Additional 9% 60% ownership 	<ul style="list-style-type: none"> Remaining 40% 100% ownership
Option type	Call and Put option	Call and Put option	Put option
Exercise price	€ 99m	€ 161m	'Fair value' or € 647m
Option trigger	<ul style="list-style-type: none"> 1m Homes Connected or 1 January 2013 	<ul style="list-style-type: none"> 1.5m Homes Connected or 1 January 2014 	<ul style="list-style-type: none"> Put vests at settlement of option II
Consolidation	No ²	Yes	Yes

Reggefiber financials FY 2013

(in € m)	
Revenue	119
Opex (excl. D&A)	36
Capex	359
Shareholder loans	526
Net bank debt	602

Indicative, simplified financials based on Dutch GAAP; Balance Sheet items per 31 December 2013

Exercise price option III

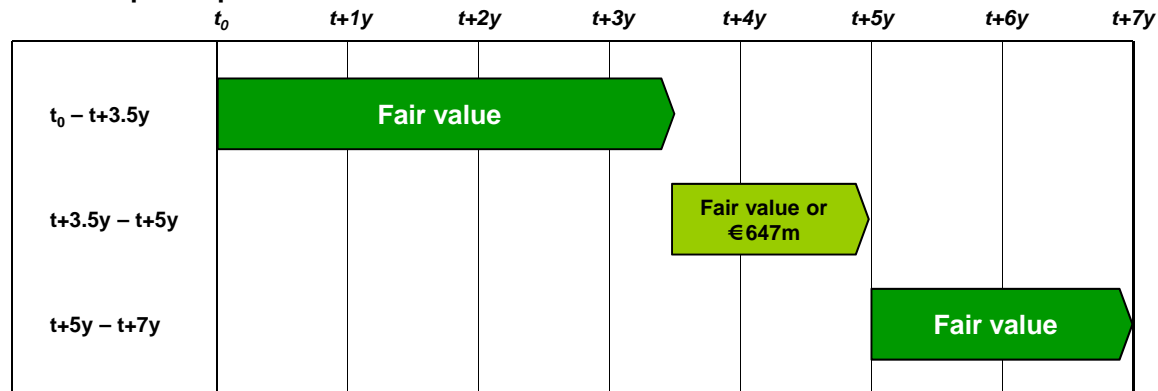

t_0 = exercise option II

Organizational chart

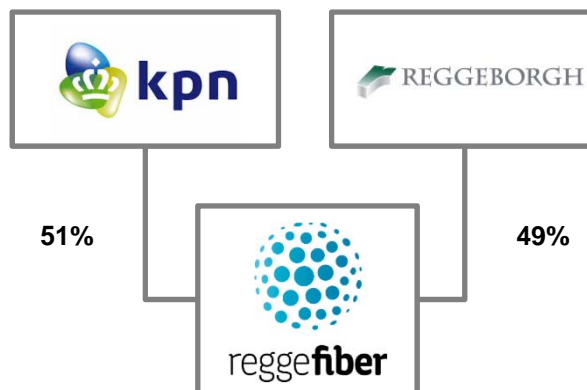

- 1 On 8 November 2012 KPN acquired an additional 10% of the shares in Reggefiber, increasing its share to 51%, for an amount of € 99m
- 2 KPN does not obtain management control at 51% ownership, therefore no consolidation triggered
- 3 Option II exercised on 2 January 2014; Dutch Competition Authority (ACM) approval is required to increase KPN ownership from 51% to 60% after which Reggefiber will be consolidated

Contents

1	KPN ADR program
2	Group results analysis
3	Debt overview
4	Regulation & Spectrum
5	Fixed infrastructure & Reggefiber
6	Telefónica Deutschland stake

Telefónica Deutschland stake

Accounting treatment

Balance sheet

- Stake will be included as financial asset¹
- Fair value of KPN's stake will be based on Telefónica Deutschland's share price and adjusted quarterly
 - Fair value movements will be recorded in *other comprehensive income*
 - Significant or prolonged value decreases will be booked as an impairment through the P&L within *net finance costs*

P&L

- Dividends received will be reported as finance income within *net finance costs*
- Upon sale of (part of) the stake, all related capital gains or losses are recognized through the P&L as *other income*
- Significant or prolonged value decreases will be booked as an impairment through the P&L within *net finance costs*

Cash flow

- Dividends received will be part of operating cash flow and free cash flow as *dividends received*

Tax

- Dividends received and/or capital gains realized (proceeds above tax book value) on KPN's stake will be subject to Dutch corporate income tax
- Deferred tax asset can be utilized to offset income related to KPN's stake

¹ Defined under IFRS as *available for sale financial asset*